

Adâncimea m	Nr de căderi N	Locația :	Tg. Mureș	Masa berbecului :	63.5 kg
0.2	1	Tip penetrometru :	DPSH-B	Înălțimea de cădere :	75cm
0.4	9	Diametru con :	50.2 mm	CTN ± 0.00 =	m
0.6	9	Secțiunea con :	20 cm <sup>2</sup>	Număr sondaj :	DPSH-B1
0.8	5	Unghi la vârf con:	90 °		

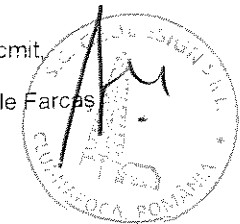

Adâncimea cm	numărul de căderi pe 20 cm Nr de căderi
0.2	1
0.4	9
0.6	9
0.8	5
1	2
1.2	1
1.4	2
1.6	2
1.8	2
2	2
2.2	1
2.4	2
2.6	2
2.8	2
3	2
3.2	2
3.4	2
3.6	14
3.8	37
4	38
4.2	24
4.4	27
4.6	24
4.8	12
5	9
5.2	9
5.4	27
5.6	23
5.8	15
6	9
6.2	20
6.4	29
6.6	
6.8	
7	
7.2	
7.4	
7.6	
7.8	
8	
8.2	
8.4	
8.6	
8.8	
9	
9.2	
9.4	
9.6	
9.8	
10	
10.2	
10.4	
10.6	
10.8	
11	
11.2	
11.4	
11.6	
11.8	
12	
12.2	
12.4	
12.6	
12.8	
13	
13.2	
13.4	
13.6	
13.8	
14	

Întocmit  
Vasile Farcas



Adâncimea m	Nr de căderi N	Locația : Tip penetrometru :	Tg. Mureș DPSH-B	Masa berbecului : Înălțimea de cădere :	63.5 kg 75cm
0.2	4	Diametru con :	50.2 mm	CTN ± 0.00 =	m
0.4	20	Secțiunea con :	20 cm <sup>2</sup>	Număr sondaj :	DPSH-B2
0.6	9	Unghi la vârf con:	90 °		
0.8	3				
1	2				
1.2	1				
1.4	0				
1.6	1				
1.8	0				
2	1				
2.2	1				
2.4	1				
2.6	1				
2.8	2				
3	6				
3.2	37				
3.4	55				
3.6	54				
3.8	42				
4	41				
4.2	29				
4.4	17				
4.6	17				
4.8	30				
5	28				
5.2	12				
5.4	6				
5.6	7				
5.8	17				
6	8				
6.2	5				
6.4	49				
6.6					
6.8					
7					
7.2					
7.4					
7.6					
7.8					
8					
8.2					
8.4					
8.6					
8.8					
9					
9.2					
9.4					
9.6					
9.8					
10					
10.2					
10.4					
10.6					
10.8					
11					
11.2					
11.4					
11.6					
11.8					
12					
12.2					
12.4					
12.6					
12.8					
13					
13.2					
13.4					
13.6					
13.8					
14					

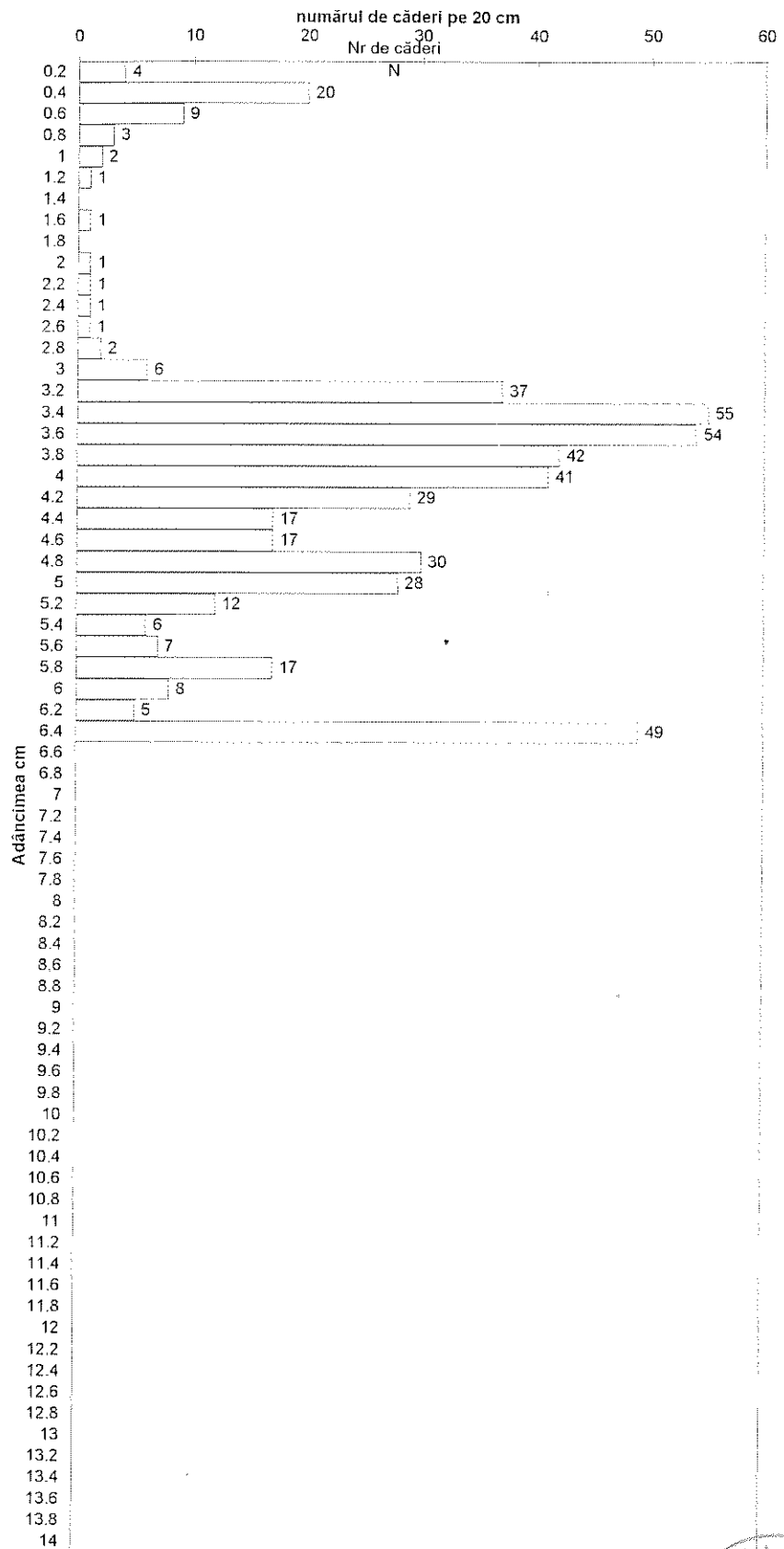

Întocmit,

Vasile Farcas



Adâncimea m	Nr de căderi N	Locația :	Tg. Mureș	Masa berbecului :	63.5 kg
0.2	6	Tip penetrometru :	DPSH-B	Înălțimea de cădere :	75cm
0.4	17	Diametru con :	50.2 mm	CTN ± 0.00 =	m
0.6	14	Secțiunea con :	20 cm <sup>2</sup>	Număr sondaj :	DPSH-B3
0.8	10	Unghi la vârf con :	90°		
1	4				
1.2	2				
1.4	1				
1.6	2				
1.8	2				
2	1				
2.2	1				
2.4	2				
2.6	2				
2.8	2				
3	2				
3.2	2				
3.4	3				
3.6	2				
3.8	18				
4	55				
4.2	49				
4.4	41				
4.6	28				
4.8	34				
5	35				
5.2	36				
5.4	29				
5.6	24				
5.8	17				
6	24				
6.2	34				
6.4					
6.6					
6.8					
7					
7.2					
7.4					
7.6					
7.8					
8					
8.2					
8.4					
8.6					
8.8					
9					
9.2					
9.4					
9.6					
9.8					
10					
10.2					
10.4					
10.6					
10.8					
11					
11.2					
11.4					
11.6					
11.8					
12					
12.2					
12.4					
12.6					
12.8					
13					
13.2					
13.4					
13.6					
13.8					
14					

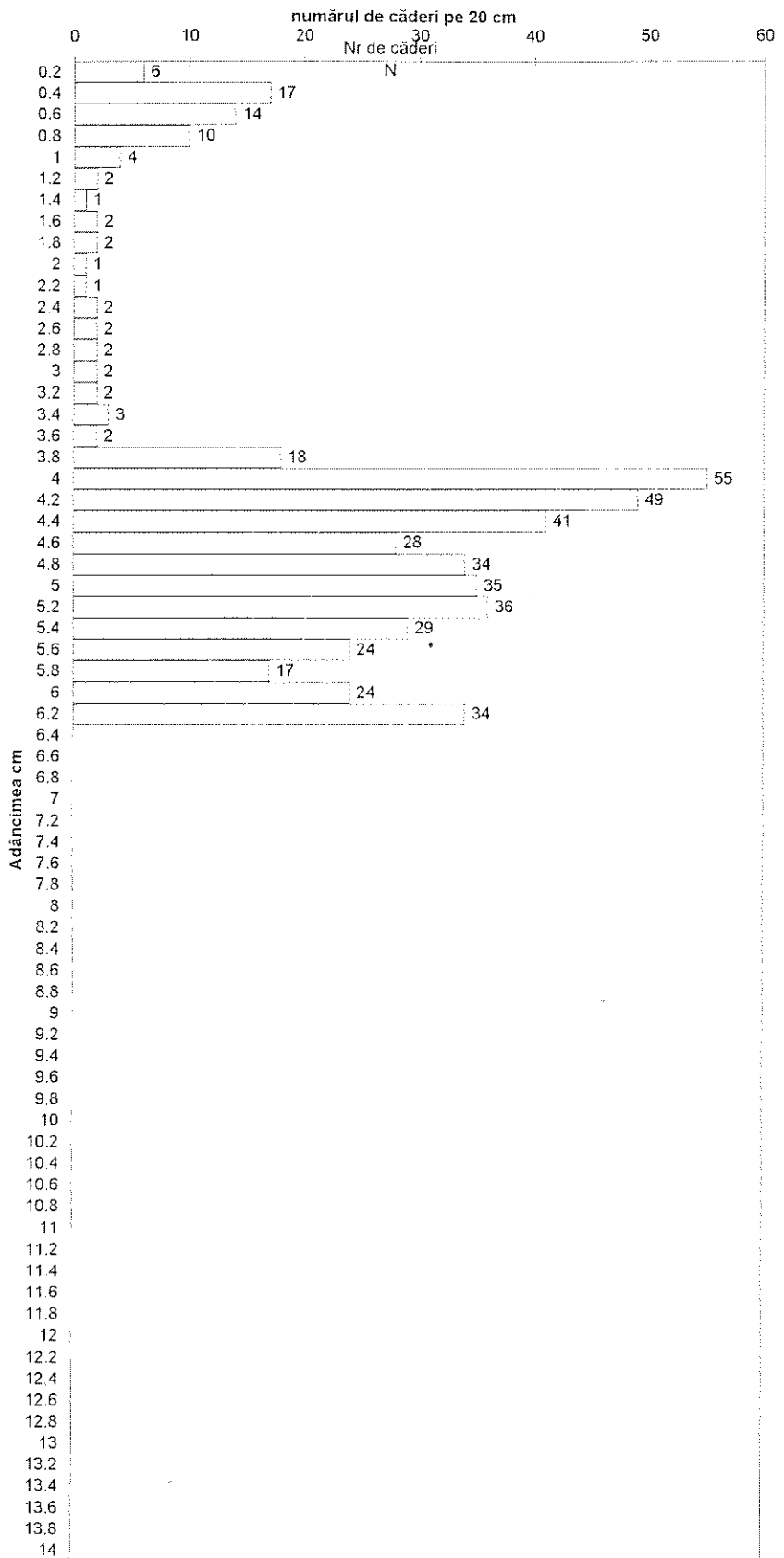

Întocmit,  
Vasile Farcăș

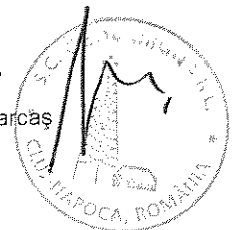

Adâncimea m	Nr de căderi N	Locația :	Tg. Mureș	Masa berbecului :	63.5 kg
0.2	0	Tip penetrometru :	DPSH-B	Înălțimea de cădere :	75cm
0.4	26	Diametru con :	50.2 mm	CTN ± 0.00 =	m
0.6	12	Secțiunea con :	20 cm <sup>2</sup>	Număr sondaj :	DPSH-B4
0.8	2	Unghi la vârf con:	90°		

  

Adâncimea cm	numărul de căderi pe 20 cm Nr de căderi
0.2	N
0.4	26
0.6	12
0.8	2
1	3
1.2	4
1.4	1
1.6	1
1.8	1
2	
2.2	2
2.4	2
2.6	2
2.8	4
3	
3.2	33
3.4	
3.6	
3.8	
4	
4.2	
4.4	
4.6	
4.8	
5	
5.2	27
5.4	17
5.6	11
5.8	8
6	
6.2	6
6.4	7
6.6	11
6.8	18
7	19
7.2	28
7.4	
7.6	
7.8	
8	
8.2	
8.4	
8.6	
8.8	
9	
9.2	
9.4	
9.6	
9.8	
10	
10.2	
10.4	
10.6	
10.8	
11	
11.2	
11.4	
11.6	
11.8	
12	
12.2	
12.4	
12.6	
12.8	
13	
13.2	
13.4	
13.6	
13.8	
14	

Întocmit,  
Vasile Farcas

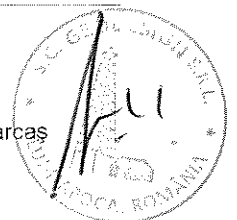

Adâncimea m	Nr de căderi N	Locația :	Tg. Mureș	Masa berbecului :	63.5 kg
0.2	5	Tip penetrometru :	DPSH-B	Înălțimea de cădere :	75cm
0.4	21	Diametru con :	50.2 mm	CTN ± 0.00 =	m
0.6	8	Secțiunea con :	20 cm <sup>2</sup>	Număr sondaj :	DPSH-B5
0.8	3	Unghi la vârf con:	90°		
1	3				
1.2	3				
1.4	4				
1.6	4				
1.8	3				
2	3				
2.2	3				
2.4	3				
2.6	3				
2.8	5				
3	5				
3.2	12				
3.4	31				
3.6	85				
3.8	84				
4	82				
4.2					
4.4					
4.6					
4.8					
5					
5.2					
5.4					
5.6					
5.8					
6					
6.2					
6.4					
6.6					
6.8					
7					
7.2					
7.4					
7.6					
7.8					
8					
8.2					
8.4					
8.6					
8.8					
9					
9.2					
9.4					
9.6					
9.8					
10					
10.2					
10.4					
10.6					
10.8					
11					
11.2					
11.4					
11.6					
11.8					
12					
12.2					
12.4					
12.6					
12.8					
13					
13.2					
13.4					
13.6					
13.8					
14					

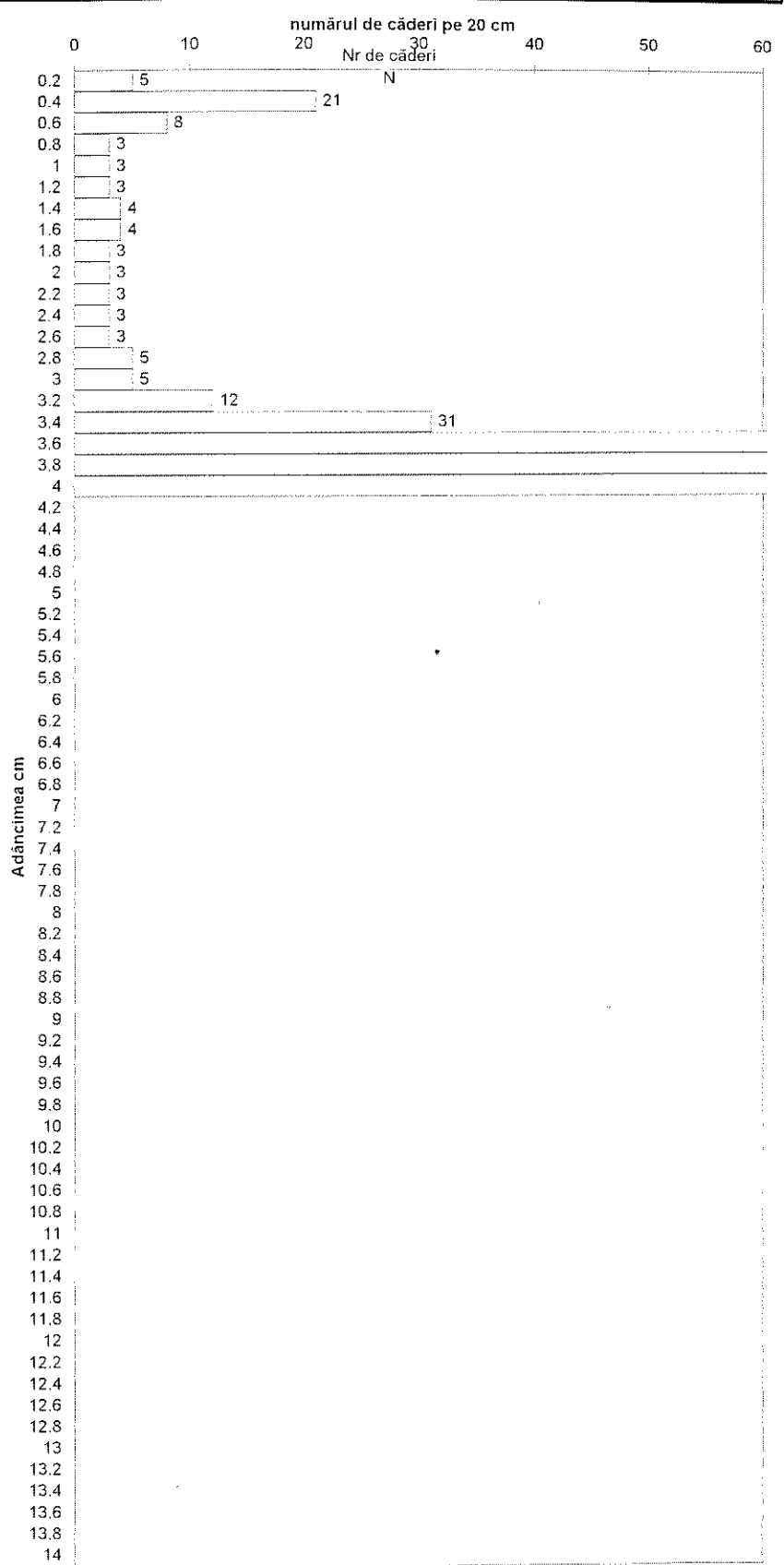

Întocmit,  
Vasile Farcas

Adâncimea m	Nr de căderi N	Locația : Tip penetrometru :	Tg. Mureș DPSH-B	Masa berbecului : Înălțimea de cădere :	63.5 kg 75cm
0.2	0	Diametru con :	50.2 mm	CTN ± 0.00 =	m
0.4	24	Secțiunea con :	20 cm <sup>2</sup>	Număr sondaj :	DPSH-B6
0.6	18	Unghi la vârf con:	90°		

0.8	7
1	2
1.2	2
1.4	2
1.6	2
1.8	2
2	2
2.2	1
2.4	2
2.6	1
2.8	3
3	6
3.2	14
3.4	8
3.6	13
3.8	45
4	79
4.2	
4.4	
4.6	
4.8	
5	
5.2	
5.4	
5.6	
5.8	
6	
6.2	
6.4	
6.6	
6.8	
7	
7.2	
7.4	
7.6	
7.8	
8	
8.2	
8.4	
8.6	
8.8	
9	
9.2	
9.4	
9.6	
9.8	
10	
10.2	
10.4	
10.6	
10.8	
11	
11.2	
11.4	
11.6	
11.8	
12	
12.2	
12.4	
12.6	
12.8	
13	
13.2	
13.4	
13.6	
13.8	
14	

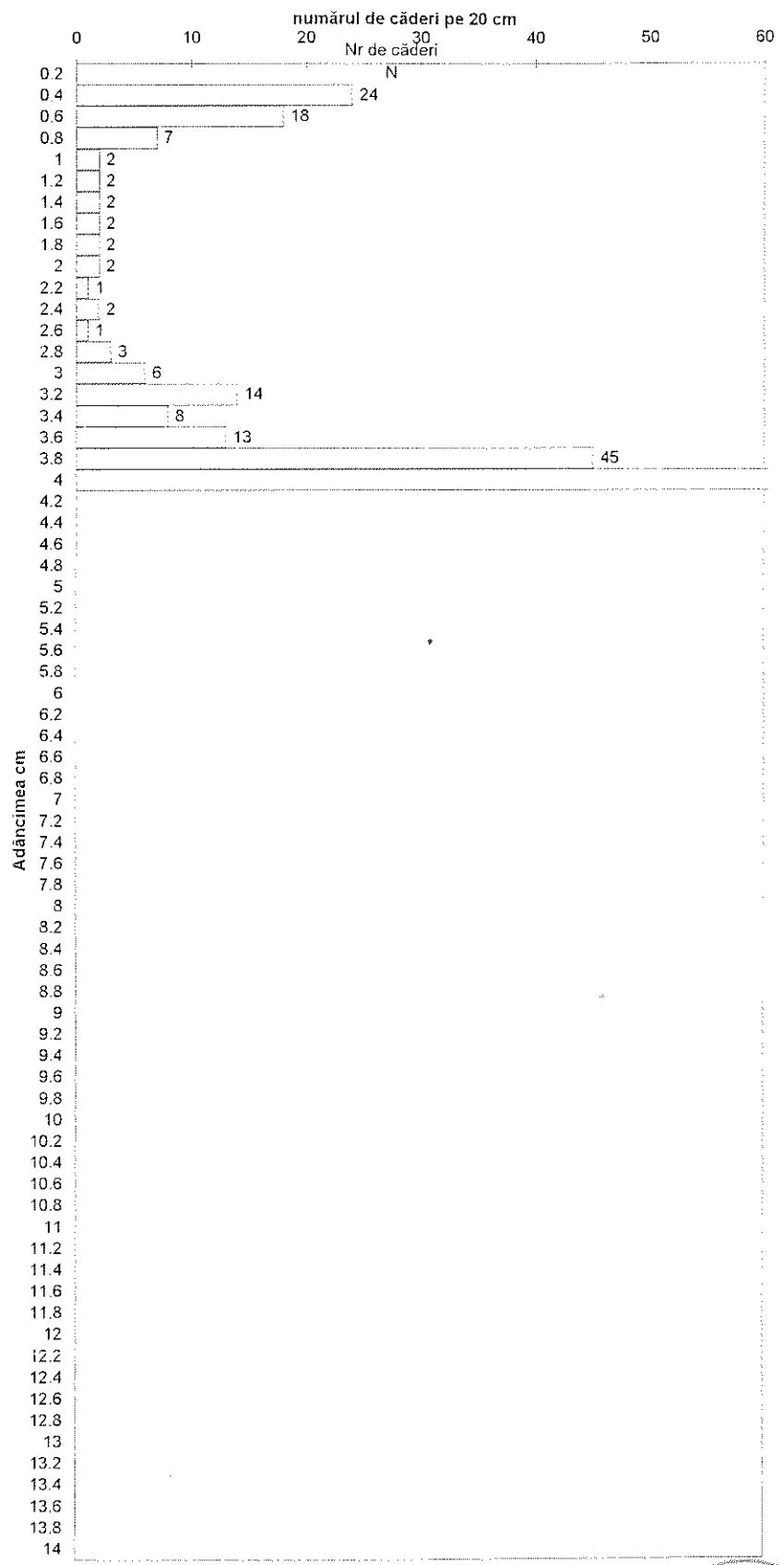

Întocmit  
Vasile Farcaș

Adâncimea m	Nr de căderi N	Locația :	Tg. Mureș	Masa berbecului :	63.5 kg
0.2	4	Tip penetrometru :	DPSH-B	Înălțimea de cădere :	75cm
0.4	16	Diametru con :	50.2 mm	CTN ± 0.00 =	m
0.6	4	Secțiunea con :	20 cm <sup>2</sup>	Număr sondaj :	DPSH-B7
0.8	2	Unghi la vârf con:	90°		

Adâncimea cm	numărul de căderi pe 20 cm N
0.2	4
0.4	16
0.6	4
0.8	2
1	2
1.2	2
1.4	3
1.6	2
1.8	1
2	2
2.2	4
2.4	5
2.6	12
2.8	33
3	45
3.2	58
3.4	72
3.6	86
3.8	76
4	58
4.2	
4.4	
4.6	
4.8	
5	
5.2	
5.4	
5.6	
5.8	
6	
6.2	
6.4	
6.6	
6.8	
7	
7.2	
7.4	
7.6	
7.8	
8	
8.2	
8.4	
8.6	
8.8	
9	
9.2	
9.4	
9.6	
9.8	
10	
10.2	
10.4	
10.6	
10.8	
11	
11.2	
11.4	
11.6	
11.8	
12	
12.2	
12.4	
12.6	
12.8	
13	
13.2	
13.4	
13.6	
13.8	
14	

Întocmit,  
  
 Vasile Farcas  

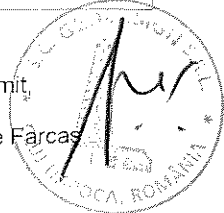
S101

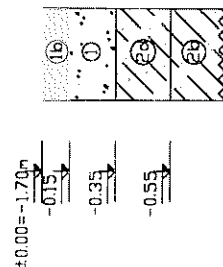
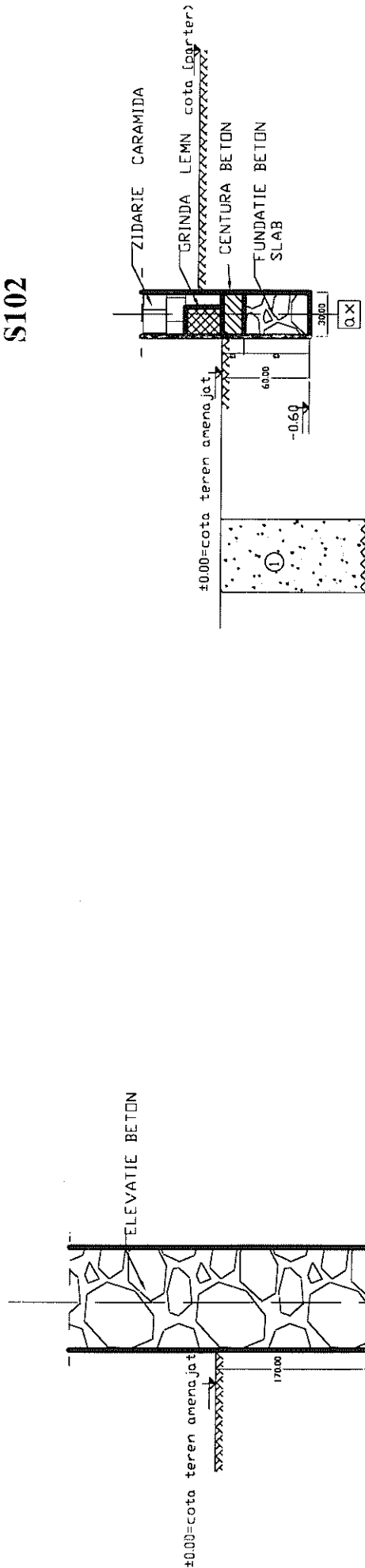

LEGENDA:

- (1b) pardoseala beton
- (1) pietris si nisip, indesarie medie (umplutura)
- (2b) prof nisipos/nisip prafos, negricios, plastic consistent
- (2b) nisip prafos, cenușu deschis, indesarie medie

S102

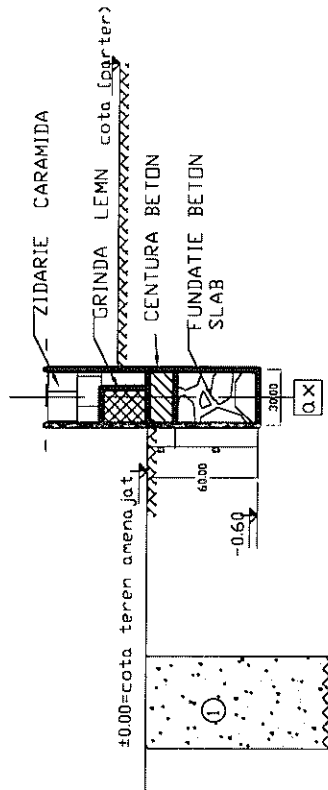

<b>S.C. GEODESIGN S.R.L.</b> str. DORNEI, nr. 42A, tel/fax: 0744-777009		Beneficiar: <b>LIDL ROMANIA SCS</b>	Planșa nr. 3
Proiectat ing. geol. Paul GROVU	Redactat ing. geol. Paul GROVU	Amplasament: <b>Str. Sinaia nr.3, TG. MURES</b>	
Verificat		Data sept. 2010	
<b>SONDAJ S101, S102</b>			



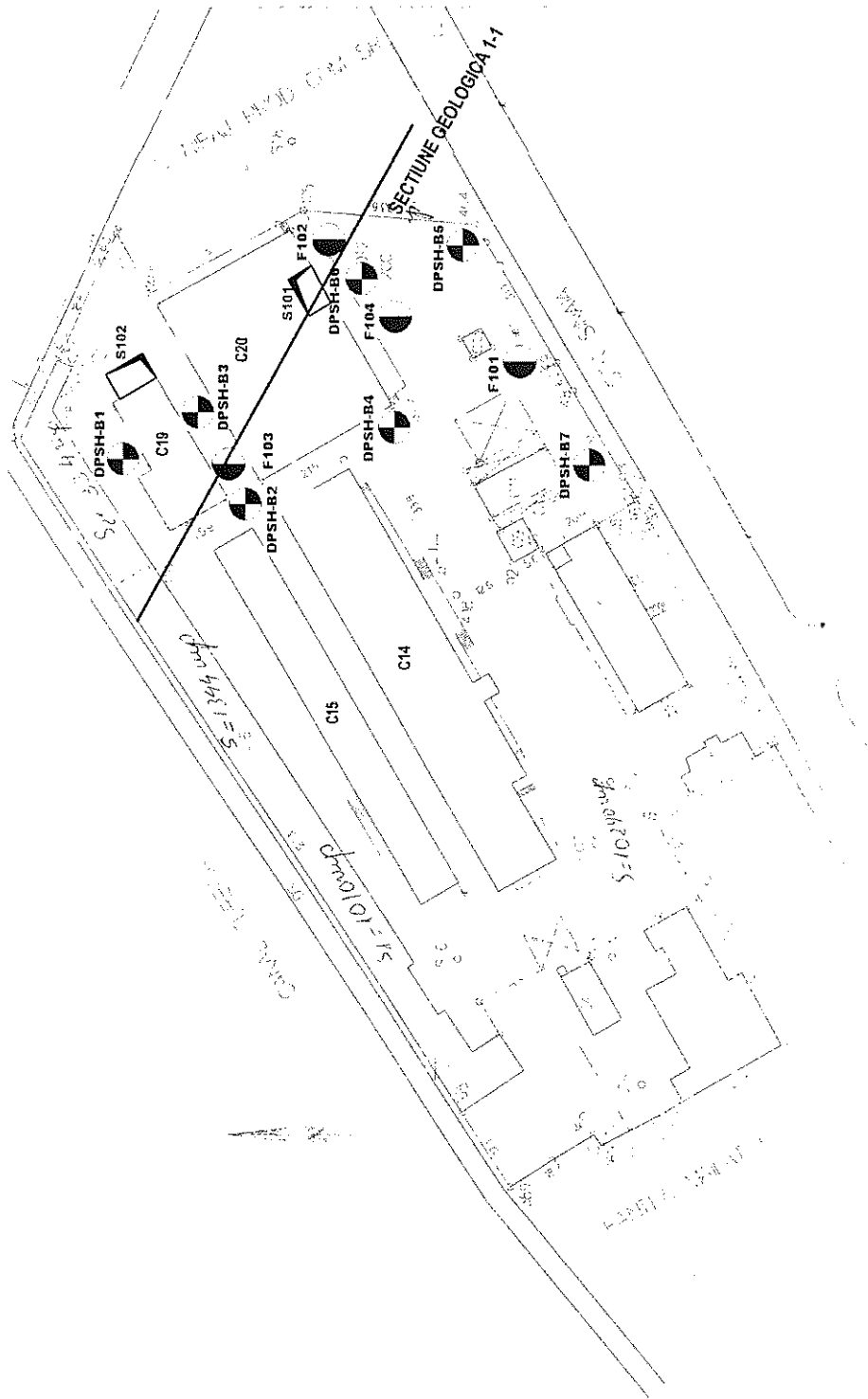

FORAJ  
 PENETRARE DINAMICA DPSH-B

<b>S.C. GEODESIGN S.R.L.</b> str. DORNEI, nr. 42A, tel/fax: 0744-777009		Beneficiar: <b>LIDL ROMANIA SCS</b> nr. 4	Planşa nr. 4
Proiectat ing. geol. Paul GROVU		Amplasament: <b>Str. Sinaia nr.3, Mun. Tg. Mures Jud. MURES</b>	
Redactat ing. geol. Paul GROVU		<b>PLAN AMPLASARE FORAJE</b>	
Verificat		Data sept 2010	

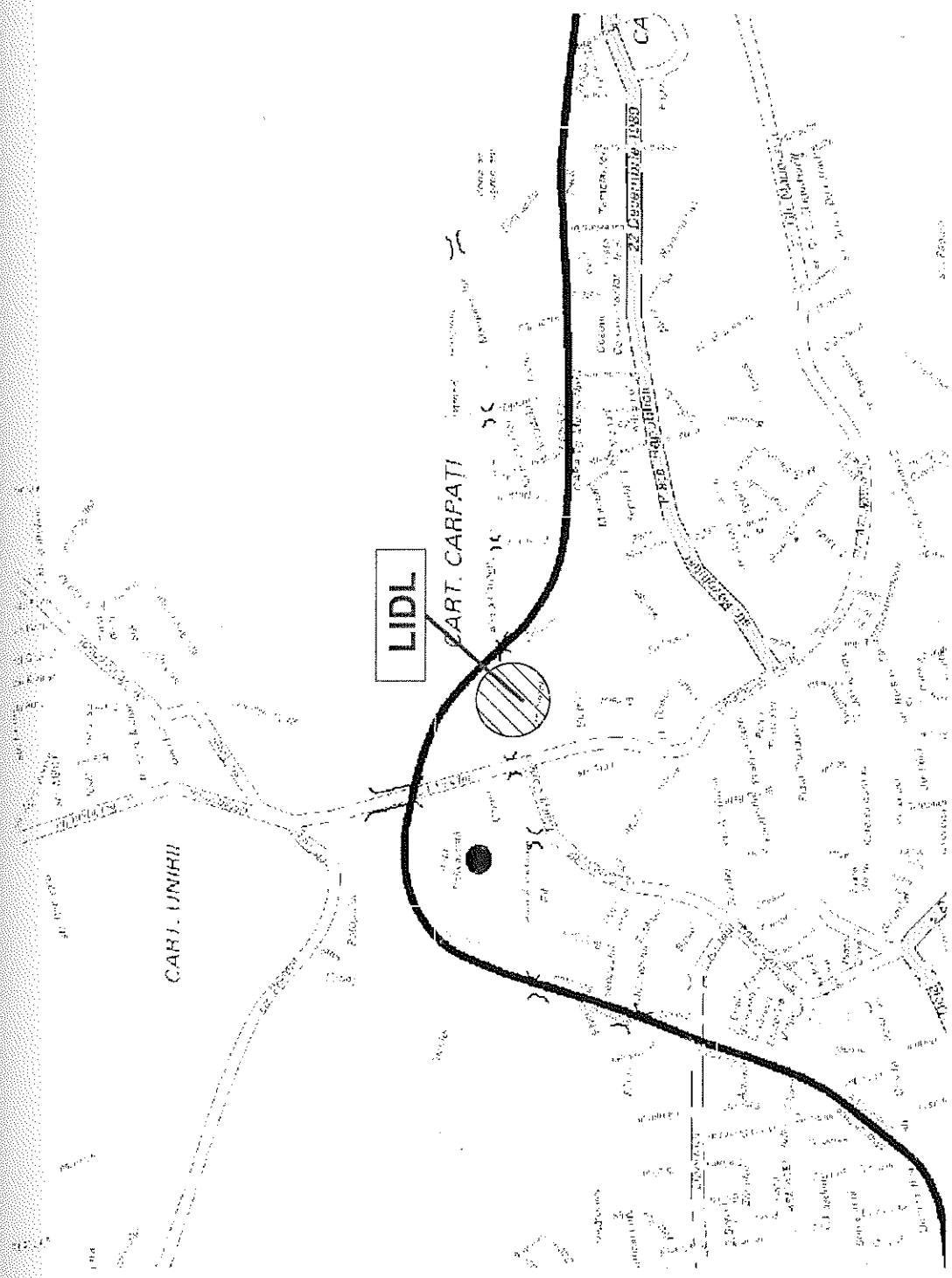

<b>S.C. GEODESIGN S.R.L.</b> str. DORNEI, nr. 42A, tel/fax: 0744-777009		<b>Beneficiar:</b> LIDL ROMANIA SCS	Planşa nr. 5
Proiectat ing. geol. Paul GROVU		<b>Amplasament:</b> Str. Sinaia nr.3, Mun. Tg. Mures, Jud. MURES	
Redactat ing. geol. Paul GROVU			
Verificat			
<b>PLAN ÎNCADRARE ÎN ZONĂ</b>			